



## Main

Range	TeSys
Product name	TeSys GV2
Device short name	GV2L
Device application	Motor
Poles description	3P
Network type	AC
Utilisation category	Category A conforming to IEC 60947-2 AC-3 conforming to IEC 60947-4-1
Network frequency	50/60 Hz conforming to IEC 60947-2
Breaking capacity	100 kA Icu at 230/240 V AC 50/60 Hz conforming to IEC 60947-2 100 kA Icu at 400/415 V AC 50/60 Hz conforming to IEC 60947-2 4 kA Icu at 690 V AC 50/60 Hz conforming to IEC 60947-2 10 kA Icu at 500 V AC 50/60 Hz conforming to IEC 60947-2 20 kA Icu at 440 V AC 50/60 Hz conforming to IEC 60947-2
[Ics] rated service short-circuit breaking capacity	100 % at 690 V AC 50/60 Hz conforming to IEC 60947-2 100 % at 500 V AC 50/60 Hz conforming to IEC 60947-2 100 % at 230/240 V AC 50/60 Hz conforming to IEC 60947-2 100 % at 400/415 V AC 50/60 Hz conforming to IEC 60947-2 75 % at 440 V AC 50/60 Hz conforming to IEC 60947-2
Trip unit technology	Magnetic
Magnetic tripping current	138 A

## Complementary

Fixing mode	35 mm symmetrical DIN rail: clipped Panel: screwed (with 2 x M4 screws)
Operating position	Any position
Motor power kW	3 kW at 400/415 V AC 50/60 Hz 4 kW at 400/415 V AC 50/60 Hz 4 kW at 500 V AC 50/60 Hz 5.5 kW at 690 V AC 50/60 Hz 7.5 kW at 690 V AC 50/60 Hz

Control type	Rotary knob
[Ue] rated operational voltage	690 V AC 50/60 Hz conforming to IEC 60947-2
[Ui] rated insulation voltage	690 V AC 50/60 Hz conforming to IEC 60947-2
[Uimp] rated impulse withstand voltage	IEC 60947-2 6 kV
Power dissipation per pole	1.8 W
Mechanical durability	100000 cycles
Electrical durability	100000 cycles for AC-3 at 415 V
Maximum operating rate	40 cyc/h
Rated duty	Continuous conforming to IEC 60947-4-1
Connections - terminals	Screw clamp terminals 2 cable(s) 1...6 mm <sup>2</sup> solid Screw clamp terminals 2 cable(s) 1.5...6 mm <sup>2</sup> flexible without cable end Screw clamp terminals 2 cable(s) 1...4 mm <sup>2</sup> flexible with cable end
Tightening torque	1.7 N.m on screw clamp terminals
Mechanical robustness	Shocks: 30 Gn conforming to IEC 60068-2-27 Vibrations: 5 Gn, 5...150 Hz conforming to IEC 60068-2-6
Suitability for isolation	Yes conforming to IEC 60947-1
Height	89 mm
Width	45 mm
Depth	97 mm
Net weight	0.33 kg

## Environment

Standards	EN/IEC 60947-2 EN/IEC 60947-4-1 CSA C22.2 No 60947-4-1 UL 60947-4-1
Product certifications	IECEE CB Scheme UL CSA CCC EAC RINA LROS (Lloyds register of shipping) DNV-GL BV
Protective treatment	TH
IP degree of protection	IP20 conforming to IEC 60529
IK degree of protection	IK04
Ambient air temperature for operation	-20...60 °C
Ambient air temperature for storage	-40...80 °C
Fire resistance	960 °C conforming to IEC 60695-2-1
Operating altitude	0...2000 m

## Offer Sustainability

Sustainable offer status	Green Premium product
REACH Regulation	<a href="#">REACH Declaration</a>
EU RoHS Directive	Compliant <a href="#">EU RoHS Declaration</a>
Mercury free	Yes
RoHS exemption information	<a href="#">Yes</a>
China RoHS Regulation	<a href="#">China RoHS declaration</a> Product out of China RoHS scope. Substance declaration for your information
Environmental Disclosure	<a href="#">Product Environmental Profile</a>
Circularity Profile	No need of specific recycling operations
WEEE	The product must be disposed on European Union markets following specific waste collection and never end up in rubbish bins

## Contractual warranty

---

Warranty	18 months
----------	-----------

---

## Tripping Curves for GV2L or LE Combined with Thermal Overload Relay LRD or LR2K

Average Operating Times at 20 °C Related to Multiples of the Setting Current

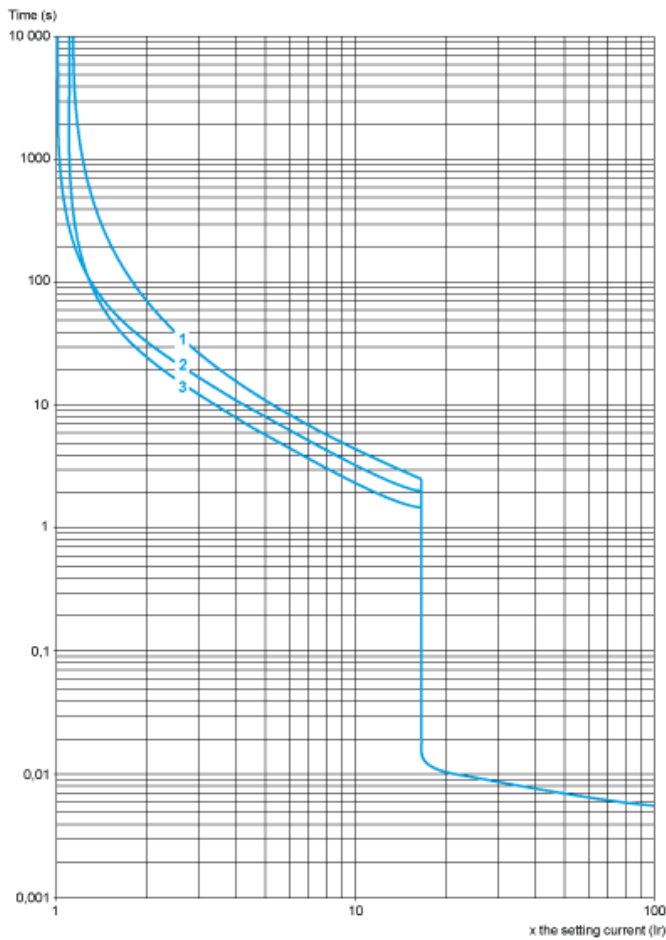

- 1 3 poles from cold state
- 2 2 poles from cold state
- 3 3 poles from hot state

## Current Limitation on Short-Circuit for GV2L and GV2LE Only (3-Phase 400/415 V)

Dynamic Stress

$I_{peak} = f(\text{prospective } I_{sc}) \text{ at } 1.05 U_e = 435 \text{ V}$

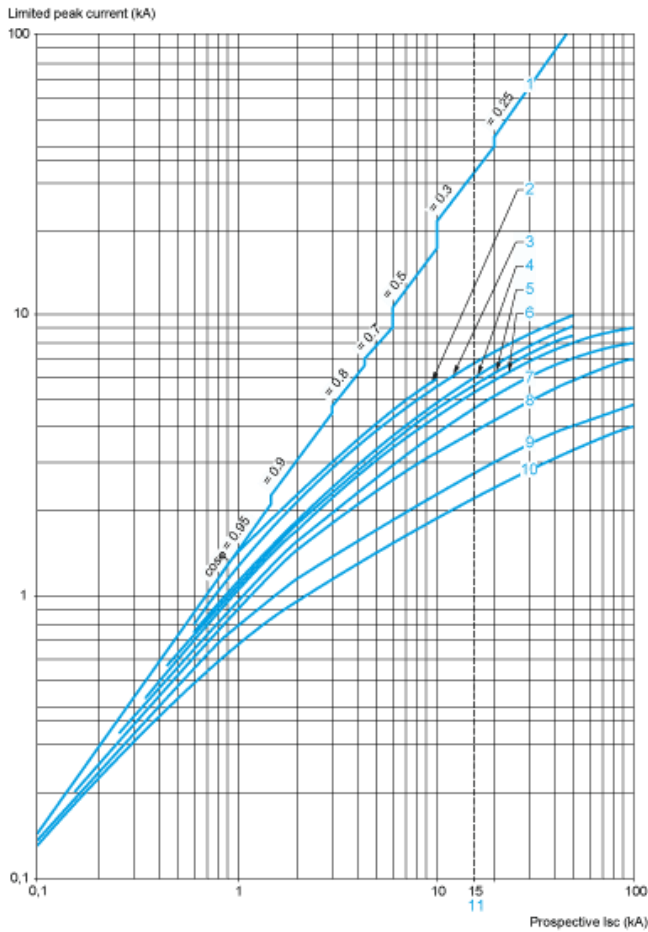

- 1 Maximum peak current
- 2 32 A
- 3 25 A
- 4 18 A
- 5 14 A
- 6 10 A
- 7 6.3 A
- 8 4 A
- 9 2.5 A
- 10 1.6 A
- 11 Limit of rated ultimate breaking capacity on short-circuit of GV2LE (14, 18, 23, and 25 A ratings).

### Current Limitation on Short-Circuit for GV2L and GV2LE + Thermal Overload Relay LRD or LR2K (3-Phase 400/415 V)

Dynamic Stress

$I_{peak} = f(\text{prospective } I_{sc}) \text{ at } 1.05 U_e = 435 \text{ V}$

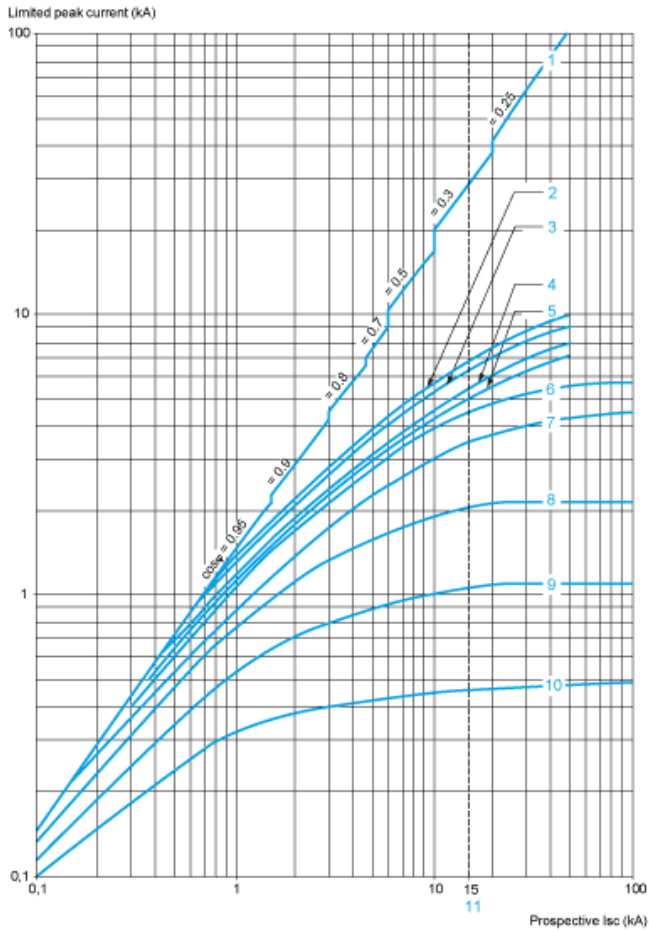

- 1 Maximum peak current
- 2 32 A
- 3 25 A
- 4 18 A
- 5 14 A
- 6 10 A
- 7 6.3 A
- 8 4 A
- 9 2.5 A
- 10 1.6 A
- 11 Limit of rated ultimate breaking capacity on short-circuit of GV2LE (14, 18, 23, and 25 A ratings).

### Thermal Limit on Short-Circuit for GV2L Only

Thermal Limit in  $kA^2s$  in the Magnetic Operating Zone

Sum of  $I^2dt = f$  (prospective Isc) at  $1.05 U_e = 435 V$

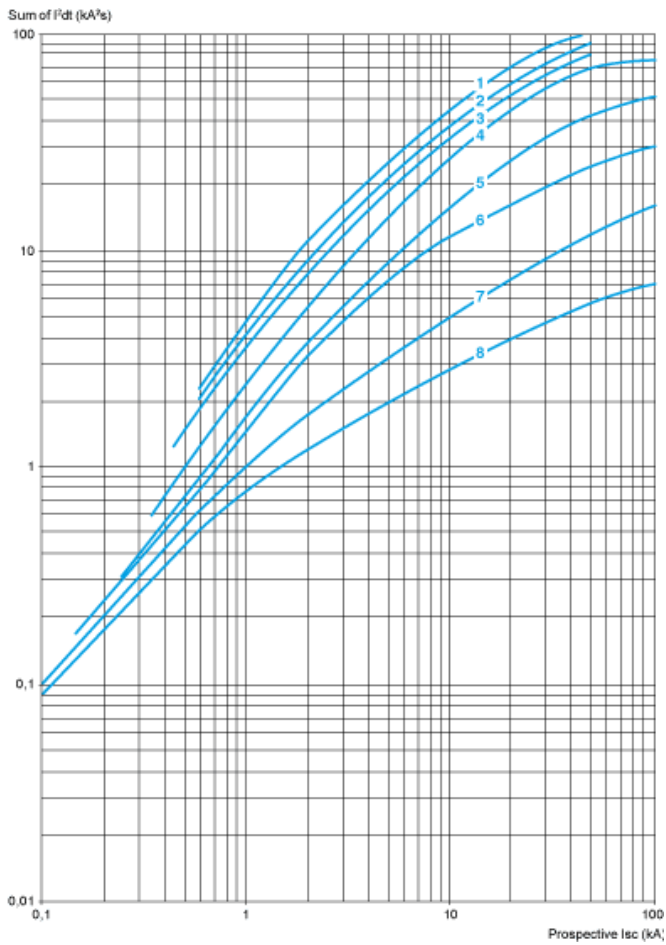

- 1 25 A and 32 A
- 2 18 A
- 3 14 A
- 4 10 A
- 5 6.3 A
- 6 4 A
- 7 2.5 A
- 8 1.6 A

### Thermal Limit on Short-Circuit for GV2L and GV2LE + Thermal Overload Relay LRD or LR2K

Thermal Limit in  $kA^2s$  in the Magnetic Operating Zone

Sum of  $I^2dt = f$  (prospective Isc) at  $1.05 U_e = 435 V$

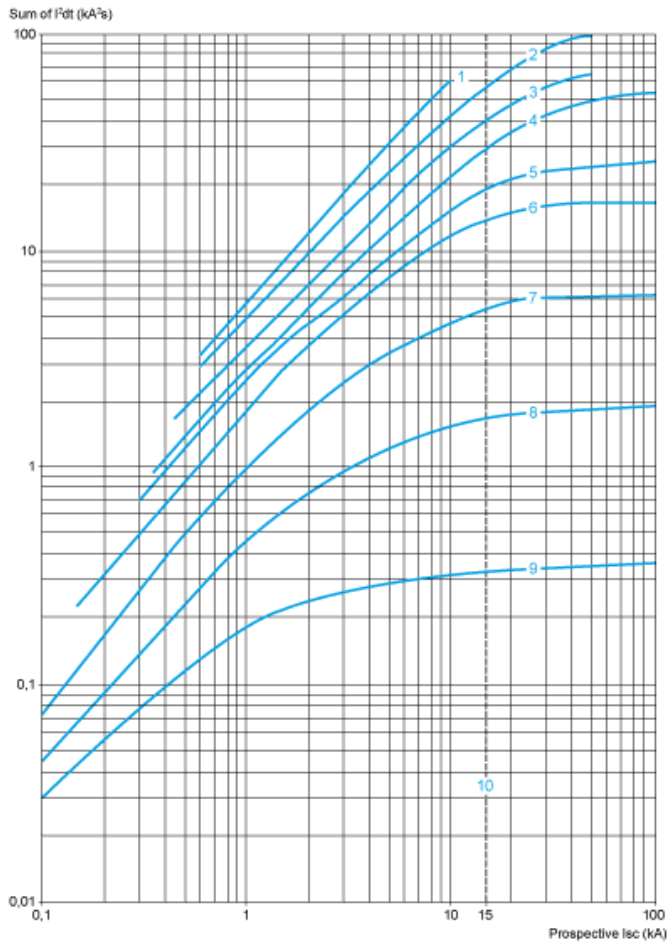

- 1 32 A (GV2LE32)
- 2 25 A and 32 A (GV2L32)
- 3 18 A
- 4 14 A
- 5 10 A
- 6 6.3 A
- 7 4 A
- 8 2.5 A
- 9 1.6 A
- 10 Limit of rated ultimate breaking capacity on short-circuit of GV2 LE (14, 18, 23, and 25 A ratings).



GV2L

Dimensions

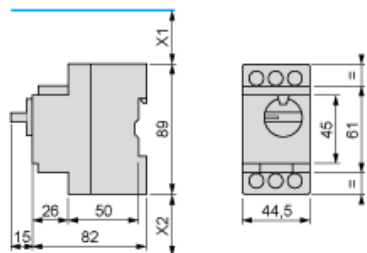

X1 Electrical clearance = 40 mm for  $U_e \leq 415$  V, or 80 mm for  $U_e = 440$  V, or 120 mm for  $U_e = 500$  and  $690$  V.

X2 = 40 mm.

GVAD, AM, AN, AU, AS

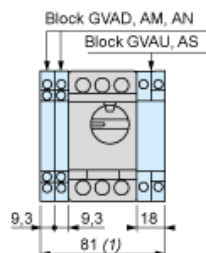

1 Maximum

GV2AK00

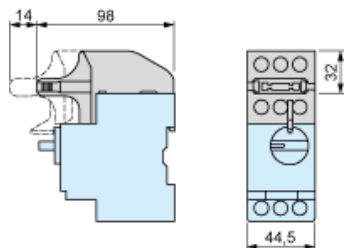

Mounting

On rail AM1 DE200, AM1 ED200 (35 x 15)



Panel mounted

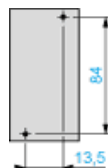

On pre-slotted mounting plate AM1 PA

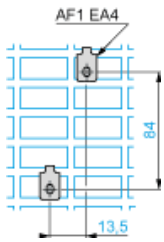

Adapter Plate GK2AF01

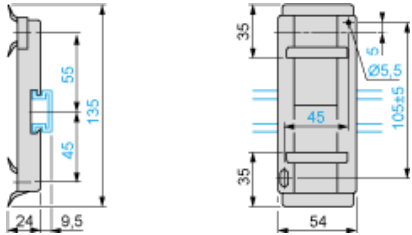

7.5 mm Height Compensation Plate GV1F03

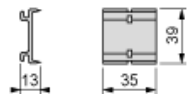

## Mounting

Mounting of External Operator GV2APN01, GV2APN02 or GV2APN04 for Motor Circuit Breakers GV2L

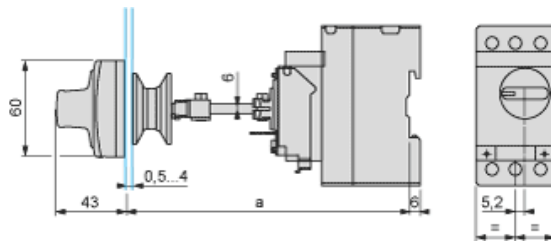

Door cut-out

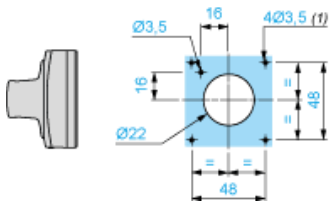

(1) For IP65 only.

Mounting of External Operator GVAPH02 for Motor Circuit Breakers GV2L

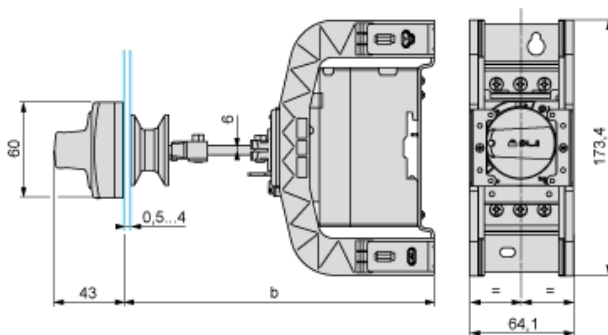

	b	
	Minimum	Maximum
GV2 APN.. + GV APH02	151	250
GV2 APN.. + GV APH02 + GV APK11	250	445

Door cut-out

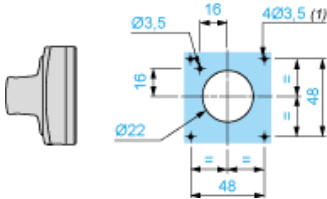

(1) For IP65 only.

GV2L and GV2LE

Sets of busbars GV2G445, GV2G454, GV2G472, with terminal block GV2G05

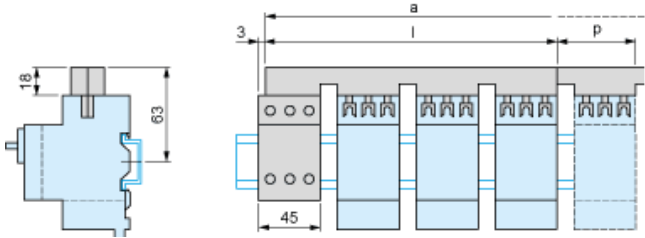

	l	p
GV2G445 (4 x 45 mm)	179	45
GV2G454 (4 x 54 mm)	206	54
GV2G472 (4 x 72 mm)	260	72

Number of tap-offs	a			
	5	6	7	8
GV2G445	224	269	314	359
GV2G454	260	314	368	422
GV2G472	332	404	476	548

Sets of Busbars for GV2L and GV2LE

Sets of busbars GV2G... with terminal block GV1G09

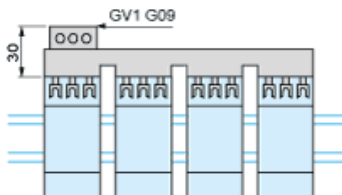

Sets of busbars GV2G245, GV2G254, GV2GR272

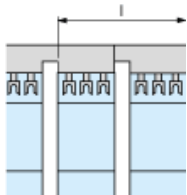

	l
GV2G245 (2 x 45 mm)	89
GV2G254 (2 x 54 mm)	98
GV2G272 (2 x 72 mm)	116

Set of busbars GV2G554

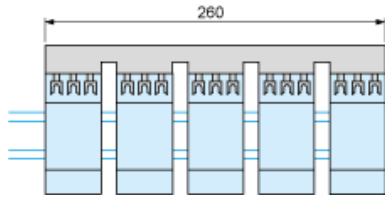

Sets of busbars GV2G345 and GV2G354

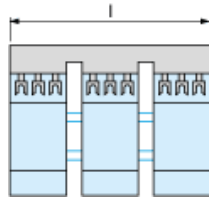

	l
GV2G345 (3 x 45 mm)	134
GV2G354 (3 x 54 mm)	152

GV2L••

